

PERCUSIÓN

Accesorios - Percusión

CINCELES

TIPO DE VÁSTAGO



Redondo .401"

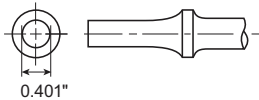

0.401"

CP7111, CP714, CP716

Hex .401"

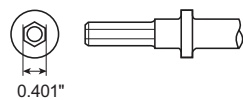

0.401"

CP7111H

Redondo .498"

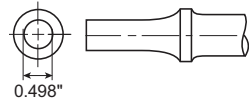

0.498"

CP717

GRÁFICO	DESCRIPCIÓN	LANCHO		ANCHO		VÁSTAGO		
		in	mm	in	mm	REDONDO .401"	HEX .401"	REDONDO .498"
	Cinzel plano	7	178	0.5	12.7	A008542		
		7	178	0.625	16			A047073
		7	178	0.75	19	A046073	CA155786	
		18	457	0.75	19	A046080		
	Rascador de capas intermedias	6.5	165	1	25	A046072		
	Separador de puntos de soldadura	7	178	1	25	A046075		
	Cortador de paneles de hoja doble	7	178	1	25	A046071		A047071
	Separador de tuercas	10	254	0.75	19	A046044		
	Cortador de remaches	6	152	0.75	19			A047050
		6.5	165	0.625	16	A046050	CA155778	
	Rascado en ángulo	7	178	1.25	32	A046063	CA155780	A047051
	Pulidora	6	152	1.75	44	A133907		
	Punta de diamante	7	178	0.3	7.6	A046064	CA155782	
	Cinzel de bordeado	5.375	137	0.625	16	A046076		

Accesorios - Percusión

CINCELES

TIPO DE VÁSTAGO

Redondo .401"

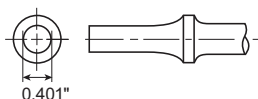

CP7111, CP714, CP716

Hex .401"

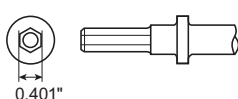

CP7111H

Redondo .498"

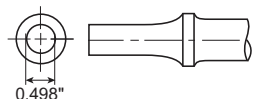

CP717



PERCUSIÓN

GRÁFICO	DESCRIPCIÓN	LANCHO		ANCHO		VÁSTAGO		
		in	mm	in	mm	REDONDO .401"	HEX .401"	REDONDO .498"
	Cinzel redondo*	7	178	0.512	13	A046074	CA155790	
	Cinzel redondo	7	178	0.498	12.5			A047074
	Punzón cónico	7	178	0.3	7.6			A047078
	Punzón cónico	7	178	0.1	2.5	A046078	CA157107	
	Separador de casquillos	7	178	-	-			A047052
	Barra de acoplamiento (junta universal)	4.25	108	0.625	16	A046057		A047057
	Extracción de remaches	3.5	89	0.125	3	A046087		
		3.5	89	0.188	5	A046088		
	Extracción de remaches	3.5	89	0.25	6	A046089		
	Martillo raspador	3	76	1.25	32	A046090		A047091
		3	76	1.75	44	A046091		
	Horquilla separadora	7	178	0.75	19			A047059
		7	178	1.25	32			A047061

PERCUSIÓN

Accesorios - Percusión



CINCELES

TIPO DE VÁSTAGO



GRÁFICO	DESCRIPCIÓN	LANCHO		ANCHO		VÁSTAGO			
		in	mm	in	mm	A	B	C	D
	Cinzel plano	4	102	0.625	16	WP123997			
		7	178	0.75	19	205 051 2803		615 804 4430	615 804 6180
		7.5	191	0.625	16	WP123996			
		7.5	191	0.75	19	P073225			
		10	254	0.75	19	615 804 6200			
	Raspador ancho	7	178	1.375	35	WP123998			
		7	178	2	50	894 016 2308		615 003 9000 ATEX	615 804 6210 ATEX
		7	178	2.5	64			615 804 4450	615 804 6190
		8.38	213	1.75	44	P070982			
	Punta redondeada	3.75	95	1.25	32	P072213			
		9	229	1.25	32	P084175			
		12	305	1.25	32	P084176			
		18	457	1.25	32	P084177			
	Formón	7	178	0.1	2,5	P073224			
		8	203	0.25	6			615 804 0620	
	Angle Scaling	6.5	165	1.375	35	205 049 9653			
		7	178	1.375	35	P084376		615 804 4440	615 804 6220
	Punta de diamante	7.5	191	0.25	6	WP123995	P073223		
	Cinzel redondo*	7	178	0.5	12.7	WP123994			
	Cinzel con punta	7	180	-	-	205 051 2793			

Accesorios - Percusión

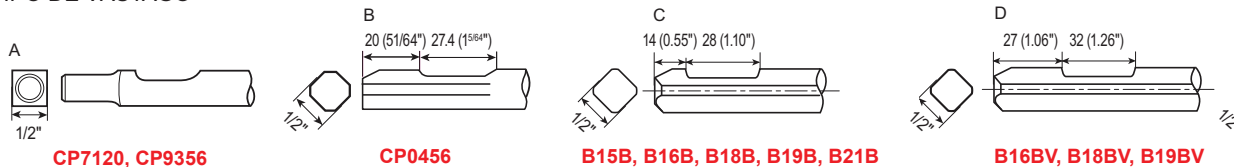

PERCUSIÓN

CINCELES

TIPO DE VÁSTAGO



GRÁFICO	DESCRIPCIÓN	LANCHO		ANCHO		VÁSTAGO	
		in	mm	in	mm	A	B
	Cinzel plano	5.7	145	0.25	6	615 041 1140	
		5.9	150	0.375	9.5	615 040 1150	
		7.9	200	0.25	6	615 041 1200	
	Cinzel redondo*	9.9	250	0.25	6	615 804 4370	
	Cinzel recto	9.9	250	0.25	6	615 804 4380	

TIPO DE VÁSTAGO

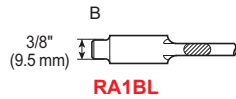
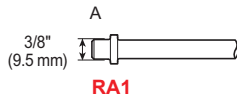

GRÁFICO	DESCRIPCIÓN	LANCHO		ANCHO		VÁSTAGO	
		in	mm	in	mm	A	B
	Cinzel plano	7.3	185	0.625	16	615 045 1180	615 046 1180
		9.9	250	0.625	16	615 804 0880	615 804 0890
		12.2	310	0.625	16	615 804 4310	
		19.7	500	0.625	16	615 804 0900	
	Cinzel plano	12.2	310	0.95	24	615 804 4400	
	Raspador ancho	9.9	250	2	50	615 804 4210	
	Cinzel redondo*	6.9	175	0.625	16	615 046 0170	
		9.45	240	0.625	16	615 046 0240	
	Cinzel picador	7.3	185	-	-	615 045 2180	615 046 2180
		9.9	250	-	-	615 804 0920	
	Cortadora de hoja	7.7	195	0.55	14	615 046 9200	

PERCUSIÓN

Accesorios - Percusión

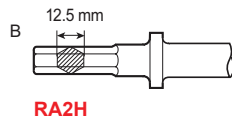

CINCELES

TIPO DE VÁSTAGO



GV5

GRÁFICO	DESCRIPCIÓN	LANCHO		ANCHO		VÁSTAGO
		in	mm	in	mm	A
	Cinzel plano	11.8	300	0.75	19	615 804 0950
		19.7	500	0.75	19	615 804 0960
	Cinzel picador	11.8	300	-	-	615 804 0930
		19.7	500	-	-	615 804 0940
	Pulidora	9.9	250	2.4	60	615 804 0970

TIPO DE VÁSTAGO

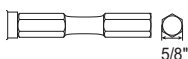

B20 Series, B19B1

GRÁFICO	DESCRIPCIÓN	LANCHO		ANCHO		VÁSTAGO
		in	mm	in	mm	A
	Cinzel plano	9	229	2	50	615 002 9000 ATEX
		9	229	2	50	615 804 4420
	Cortador de asfalto	8	203	4	100	615 804 4410
	Pulidora	-	-	4	102	615 002 9010
	Hojas para pulidora x5					615 250 5270
	Pulidora	-	-	8	203	615 002 9020
	Hojas para pulidora x5					615 250 5280
	Soporte de peines	8	203	-	-	615 002 9030
	Hojas de peines	-	-	1	25	615 250 5390

TIPO DE VÁSTAGO

CP93XX Series

A. 680 HEX / CUELLO OVAL

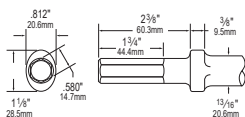

B. 680 REDONDO / CUELLO OVAL



GRÁFICO	DESCRIPCIÓN	LANCHO		ANCHO		VÁSTAGO
		in	mm	in	mm	A
	Cinzel de pico	9	230	-	-	615 813 2170 615 813 2320
		12	305	-	-	615 813 2180 615 813 2330
		18	450	-	-	615 813 2190 615 813 2340
		24	610	-	-	615 813 2200 615 813 2350
	Cinzel Plano	9	230	15/16	23,8	615 813 2210 615 813 2360
		12	305	15/16	23,8	615 813 2220 615 813 2370
		18	450	15/16	23,8	615 813 2230 615 813 2380
		24	610	15/16	23,8	615 813 2240 615 813 2390
	Cinzel ancho	9	230	1 1/2	40	615 813 2250 615 813 2400
		12	305	1 1/2	40	615 813 2260 615 813 2410
		18	450	1 1/2	40	615 813 2270 615 813 2420
		9	230	2	50	615 813 2280 615 813 2430
	Cinzel ancho	12	305	2	50	615 813 2290 615 813 2440
		18	450	2	50	615 813 2300 615 813 2450
		9	230	2	50	615 813 2310 615 813 2460
	Cojinete	9.5	240	1 3/4 sq	44,5 carré	615 813 2310 615 813 2460



Accesorios - Percusión

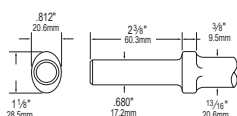

PERCUSIÓN

CINCELES

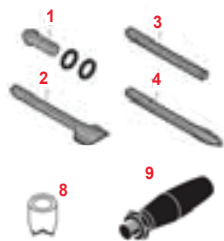

MODELO	ART.	DESCRIPCIÓN	REFERENCIA
CP9361	1	Chabota para uso con cinceles y romos	P054207
	2	Cinzel plano	P054183
	3	Cinzel plano	P054184
	4	Cinzel de morro redondo	P054182
	-	Funda transportadora	P137979
B14/B23	8	Broca en cruz, vástago cónico (punta de carburo)	615 250 5450
	9	Mango lateral	615 576 5130
	-	Arandela	615 746 5290

AGUJAS

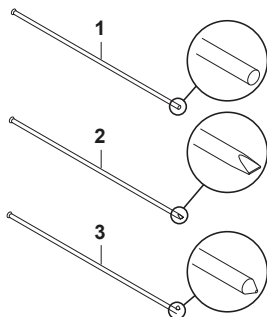

- 1 - Tipo plano : Efecto de pulido y tratamiento ligero
- 2 - Tipo cinzel : Marcado ligero de la superficie
- 3 - Tipo con punta : Raspado muy pronunciado

Agujas anti-chispas. Chispa fría para su uso en zonas potencialmente explosivas.

Agujas de acero inoxidable. Para uso en aplicaciones en las que la corrosión o la humedad supongan un problema, como en la industria del procesamiento de alimentos

MODELO USADO	ART.	DIÁMETRO		DIÁMETRO		UNIDADES POR PAQUETE	REFERENCIA
		in.	mm	in.	mm		
B15M, CP0951	1	1/8	3	7	178	12	NP123901
B19M, B19MV	1	1/8	3	7	178	28	NP123903
B19M, B21M	1	5/32	4	7	178	100	615 399 8180
	3	5/32	4	7	178	100	615 399 8220
CP7115	1	1/8	3	5	127	12	895 101 1498
CP7125, B15M	1	5/64	2	7	178	29	NP123905
CP7125, B15M, B16M, B18M, B19M	1	5/64	2	7	178	100	615 399 8160
CP0952	1	5/64	2	7	178	53	NP123906
CP7120, CP7125, B16M, B16MV, B18M, B18MV, CP0456, CP9356	1	1/8	3	5	127	19	P136403
	1	1/8	3	7	178	19	894 015 9860
CP7120, CP7125, B16M, B16MV, B18M, B18MV, CP0456, CP9356	1 (Acero fino)	1/8	3	7	178	19	P100146
	1 (Acero inoxidable)	1/8	3	7	178	19	P106454
1	1/8	3	7	178	100	615 399 8170	
CP7120, CP7125, B15M, B16M, B16MV, B18M, B18MV, B19M, B19MV, B21M, CP0456	1 (Anti-chispas)	1/8	3	7	178	100	894 017 1565
	1	1/8	3	7	178	250	NP137638
2	1/8	3	7	178	100	615 399 8190	
3	1/8	3	7	178	100	615 399 8210	
CP0952	1	1/8	3	7	178	23	NP123902

PORTA AGUJAS

Las herramientas CP pueden utilizar distintos tipos de agujas para adaptarse a una gama de aplicaciones aún mayor

MODELO USADO	CAPACIDAD		
	5/64" (2 mm)	1/8" (3 mm)	5/32" (4 mm)
B15M	615 250 5310 (Qty 29)	615 250 5210 (Qty 12)	
B16M	615 250 5320 (Qty 51)	615 250 5140 (Qty 19)	
B18M	615 250 5320 (Qty 51)	615 250 5140 (Qty 19)	
B19M	615 250 5430 (Qty 65)	615 250 5170 (Qty 28)	615 250 5330 (Qty 19)
B21M		615 250 5370 (Qty 49)	615 250 5290 (Qty 35)
CP7125	895 101 1512 (Qty 29)	895 101 1513 (Qty 19)	
CP0952	NP123918 (Qty 53)	NP123922 (Qty 23)	

MANGOS DE GOMA PARA PISONES DE ARENA



REFERENCIA	TAMAÑO						MODELO
	D		d		H		
	in.	mm	in.	mm	in.	mm	
541 205 5532	2.0	51	0.46	11.8	2.36	60	CP0200-B18 Series
541 205 5534	2.0	51	0.54	13.75	2.36	60	CP0200-B22 Series
541 205 5535	2.64	67	0.68	17.25	3.15	80	CP0200-B25 Series
541 205 5536	2.95	75	0.74	18.75	3.62	92	CP0200-B32 Series

PERCUSIÓN

Accesorios & Dimensiones - Percusión



RETENEDORES

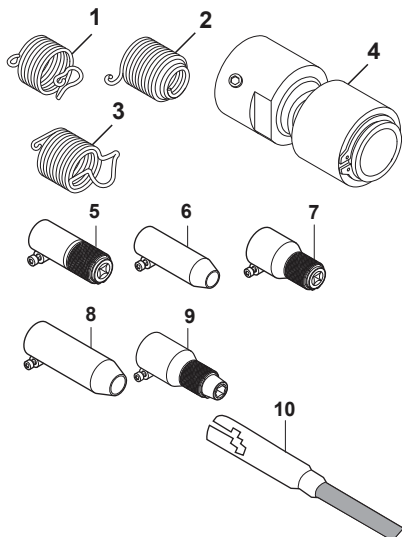

MODELO USADO	ART.	REFERENCIA	DESCRIPCIÓN	
B15B(M)	5	615 250 5240	Retén de herramienta cuadrada de 1/2"	
	6	615 250 5230	Camisa ajustable redonda	
B16B(M) / B18B(M)	5	615 250 5250	Retén de herramienta cuadrada de 1/2"	
	7	615 250 5380	Camisa ajustable redonda	
B19B(M)	8	615 250 5190	Retén de herramienta cuadrada de 1/2"	
B19B1	9	615 250 5260	Retén de herramienta hexagonal de 5/8"	
B21B(M)	7	615 250 5360	Retén de herramienta cuadrada de 1/2"	
CP7111 / CP714	1	205 048 7413	Cambio rápido	
	1	A046095	Cambio rápido de alto rendimiento	
	2	A046096	Colmena	
	3	205 052 5333	Cambio de cremallera	
	3	A046094	Cambio de cremallera de alto rendimiento fabricado en EE.UU.	
	4	894 015 8924	Cambio rápido de bloqueo Posi	
	4	A121721	Cambio rápido de bloqueo Posi fabricado en EE.UU.	
	CP716	1	CA157640	Cambio rápido
	CP717	1	A047095	Retén de cambio rápido
		2	A047096	Colmena
CP9356	10	P136983	Round Nose	

DIMENSIONES

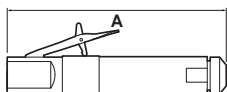

MODELO	A	
	in.	mm
B15B	8	201
B16B	9	231
B16BV	16.7	425
B15M	13.2	335
B16M	14.4	366
B16MV	14.2	360
CP0456 LASAN	16.3	413
CP0456 LESAR	8.6	219
CP0951	13.4	340
CP7115	11.4	290
CP7120	18	457
CP9356NS	9.4	238
CP9356WF	9.4	238

Para conocer las dimensiones de la serie B20, consulte la tabla p.160

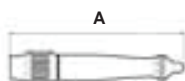
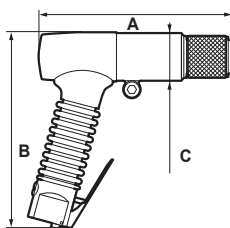

TRAZADOR DE AIRE	A	
	in.	mm
CP9160	5.8	127
CP9361	5.0	147

FORMA DE PISTOLA	A		B		C	
	in	mm	in	mm	in	mm
B18B	6.8	173	6,7	170	1.7	43
B18BV	16.5	420	7	180	2	50
B18M	12.4	315	6,7	170	1.9	48
B18MV	13.4	340	7	180	2	50
B19B	7.5	191	7	180	2	51
B19B1	8.6	218	7	180	2	51
B19BV	17.7	450	7	180	2.3	58
B19M	13.5	342	6,7	177	2.4	60
B19MV	14.8	375	7	180	2.3	58
B21B	12.2	310	6,5	165	2.4	60
B21M	19.0	484	6,5	165	2.6	66
CP0952	12.6	320	-	-	2.5	64
CP7111	7.5	190	5.7	145	1.6	40
CP7125	12.4	315	4.7	120	1.7	45
CP714	7.7	195	6.1	155	2	50
CP716	7.5	190	-	-	1.6	40
CP717	8.7	220	6.1	155	2.4	60
GV5	15.2	385	-	-	-	-
RA1	7.5	190	5,1	130	1,2	30
RA1BL	7.5	190	5,1	130	1,2	30
RA2C	8.3	210	5,9	150	1,6	40
RA2H	8.3	210	5,9	150	1,6	40

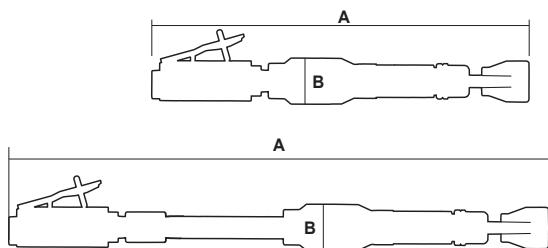

PISONES	A		B	
	in	mm	in	mm
CP0200B18-2F	15.4-17.3	390-440	1.8	46
CP0200B18L-2F	21.3-23.3	542-592	1.8	46
CP0200B22-2F	18.3-20.8	465-529	2.0	50
CP0200B22L-2F	24.2-26.7	614-678	2.0	50
CP0200B25-2F	24.8-28.1	630-713	2.4	60
CP0200B25L-2F	40.9-44.1	1038-1121	2.4	60
CP0200B32L-2F	44.2-49.2	1123-1250	2.7	68



DIMENSIONES

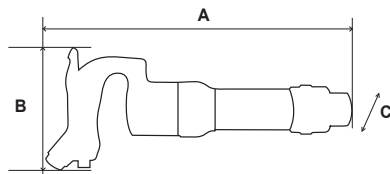

MANGO CON CUELLO DE CISNE	A		B		C	
	in	mm	in	mm	in	mm
CP9362-2R/2H	12.6	320	5.9	150	2.4	62
CP9363-1R/1H	14.0	355	6.7	170	3	76
CP9363-2R/2H	15.4	390	6.7	170	3	76
CP9363-3R/3H	17.3	440	6.7	170	3	76
CP9363-4R/4H	18.5	470	6.7	170	3	76

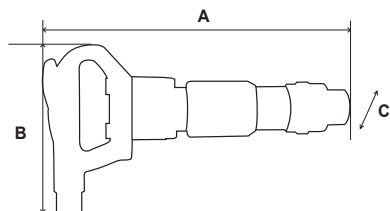

MANGO EN D	A		B		C	
	in	mm	in	mm	in	mm
CP9373-2R/2H	14.6	370	8.7	220	3.1	80
CP9373-3R/3H	15.7	400	8.7	220	3.1	80
CP9373-4R/4H	16.7	425	8.7	220	3.1	80

Kits

CP717 Kit

Ref No. T025365

El kit incluye:

- (1) Martillo neumático CP717
- (1) Cortador de panel de hoja doble - A047071
- (1) Cortadora de remaches - A047050
- (1) Martillo de Suavizado 1-1 / 4 " - A047091
- (1) Punzón recto - A047074



CP714 Kit

Ref No. T025364

El kit incluye:

- (1) Martillo neumático CP714
- (1) Cíncel plano - A046073
- (1) Cíncel taponado - A046078
- (1) Cíncel en blanco - A046074
- (1) Cortador de panel de hoja doble - A046071



CP9361-1

Ref No. T011970

El kit incluye:

- P043886 Manguera de aire - orificio de 3/16 "(5 mm) - L: 8 pies (2.4 m)
- P056381 Conjunto del filtro de aire
- P054177 Stylus - punta de carburo
- P054207 Yunque para uso con cínceles y espacio en blanco
- P054183 Cíncel plano
- P054184 Cíncel en blanco
- P054182 Cíncel de punta redonda
- P137979 Estuche portátil

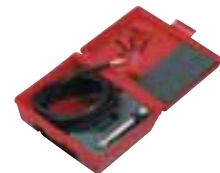

CP7111 Kit

Ref No. 894 117 1110

El kit incluye:

- (1) Martillo CP7111
- (1) Cizalla Falt - A046073
- (1) Tapen Puch - A046078
- (1) Separador de soldadura por puntos - A046075
- (1) Cortadora de panel de una sola hoja
- (1) Cizalla de borde
- (1) Retenedor de cambio rápido - 205 048 7413
- (1) Lubricante - 205 052 4123



CP7111HEX Kit

Ref No. 894 117 1111

El kit incluye:

- (1) Martillo CP7111H
- (1) Cíncel de Falt - CA155786
- (1) Tapenado Puch - CA157107
- (1) Splitter de soldadura por puntos - CA155792
- (1) Cortadora de panel de una sola hoja
- (1) Cizalla de borde
- (1) Retenedor de cambio rápido - 205 048 7413
- (1) Lubricante - 205 052 4123

TUNE-UP KITS

MODELO	TUNE-UP KIT
CP0200B..(L)-2F	894 017 0210
CP7111/7111H	205 050 6823
CP7115	894 016 9996
CP7120	205 050 6933
CP7125	894 016 9838
CP9160	205 050 6913
CP9363-x	615 398 8300
CP9373-x	615 398 8310

